

INSTALLATION INSTRUCTIONS CEILING ROSES

ORAC[®]
DECOR

INSTALLATIE VAN ROZETTEN | INSTALLATION DES ROSACES |
INSTALLATION VON ROSETTEN | INSTALACIÓN DE ROSETONES |
ИНСТРУКЦИЯ ПО УСТАНОВКЕ ПОТОЛОЧНЫХ РОЗЕТОК



R08
(Ø38 cm)



R52
(Ø69,5 cm)

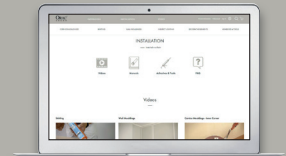

WWW.ORACDECOR.COM
>> INSTALLATION

UM365 - 09/2021

1 Ready? ATMOSPHERE & SURFACE



Storage and installation conditions: Store profiles and adhesives at room temperature and wait 24 hours before installing.
Opslag- en plaatsingsvoorwaarden: Plaats profielen en lijmen 24 uur vóór de installatie op kamertemperatuur.
Conditions d'installation et de stockage: Stockez les profils et les colles à température ambiante 24 heures avant la pose.
Lager- und Installationsbedingungen: Profile und Kleber 24 Stunden vor Verlegung bei Zimmertemperatur lagern.
Condiciones de almacenamiento y de instalación: Colocar molduras y adhesivos en el lugar 24 horas antes de la aplicación.
Условия хранения и монтажа: Оставьте профили и клей в комнате, которой планируется монтаж, на 24 часа.



Dust free
Stofvrij
Sans poussière
Staubfrei
Libre de polvo
Удалите пыль



Sand and wash surface
Schoor en reinig de ondergrond
Poncez et nettoyez la surface
Schleifen und reinigen Sie den Untergrund
Superficie lisa y limpia
Очистите поверхность



Flat wall & ceilings
Vlaakse wand en plafond
Mur et plafond plats
Plane Wand und Decke
Paredes y techos lisos
Выровняйте стены и потолок



Dry
Droog
Sec
Trocken
Seco
Высушите



No grease
Vetvrij
Sans graisse
Fettfrei
Sin grasa
Обезжирьте

Ready? Set? Go!
✓ **INSTALLATION
GUARANTEE**

2 Set? DECOFIX ADHESIVES



Interior, porous and dry surface
Binnen, poreuze en droge ondergronden
Pose à l'intérieur, surfaces poreuses, pièces non humides
Innen, poröse/saugfähig, und trockene Untergründe
Interior, superficies porosas y secas
Для внутренних работ, пористых и сухих поверхностей



Heavy profiles
Zware lijsten
Grandes molduras
Grosse Profilen
Perfiles pesados
Тяжелые профили



Exterior, non-porous or humid surface
Buiten, niet-poreuze of vochtige ondergronden
Pose à l'extérieur, surfaces non poreuses ou environnement humide
Außen, nicht-poröser/saugfähige Untergrund oder Feuchträume
Exterior, superficies no porosas o ambientes húmedos
Для внешних работ, непористых или влажных профилей



Seal wall/ceiling
Verbinding muur/plafond
Collage mur/plafond
Verbindung Wand/Decke
Adherencia techos/paredes
Стены/потолки



DecoFix Pro
Strong, water-based acrylic installation adhesive

FDP500 310ml | 7 > 8m
FDP600 4200ml | 65 > 110m



DecoFix Power
Very strong MS-Polymer-based installation adhesive

FDP700 290 ml | 7 > 8m



Joints between mouldings
Verbinding tussen profielen
Joints entre les profils
Nahtverbindungen zwischen Profilen
Uniones de los perfiles
Стыки между профилями



DecoFix Extra
Polyurethane-based adhesive

FX200 310ml | min. 80m
FX210 tube 80ml | min. 20m



DECOFILLER



DecoFiller
Ready to use lightweight acrylic filler

FL300 310 ml | 30m



3

Go!

INSTALLATION

INSTALLATION INSTRUCTIONS CEILING ROSES

ONLY FULL GUARANTEE WITH DECOFIX

VOLLEDIGE GARANTIE ENKEL BIJ GEBRUIK VAN DECOFIX

GARANTIE TOTALE UNIQUEMENT AVEC COLLE DECOFIX

VOLLSTÄNDIGE GARANTIE NUR BEI DER VERWENDUNG VON DECOFIX

GARANTÍA COMPLETA SÓLO SI SE UTILIZA DECOFIX

ГАРАНТИЯ НА ПРОДУКЦИЮ ДЕЙСТВУЕТ ТОЛЬКО ПРИ ИСПОЛЬЗОВАНИИ КЛЕЯ DECOFIX

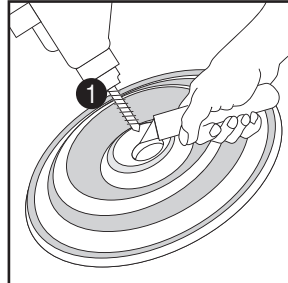
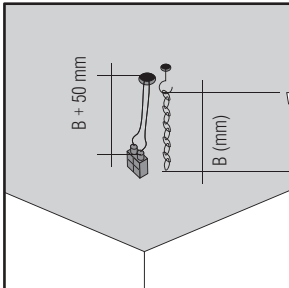
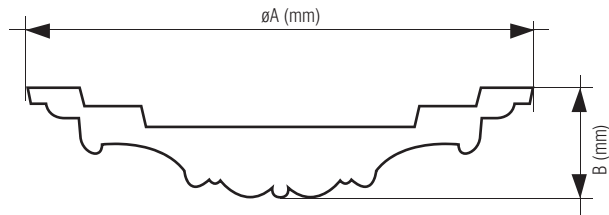

Ø < 65cm

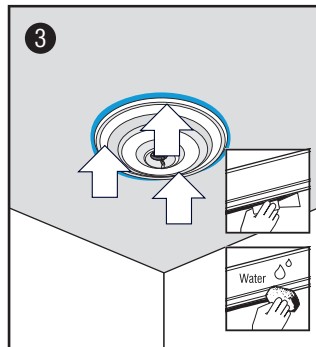
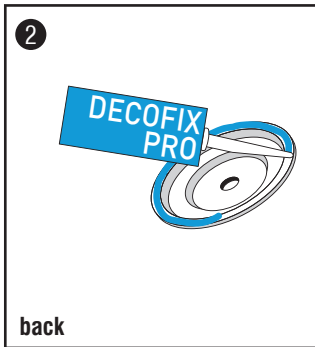

Ø > 65cm

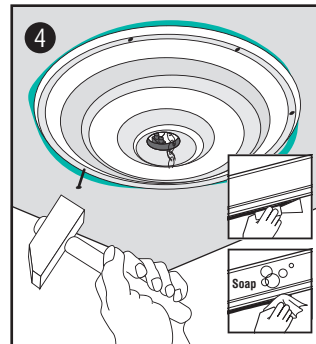
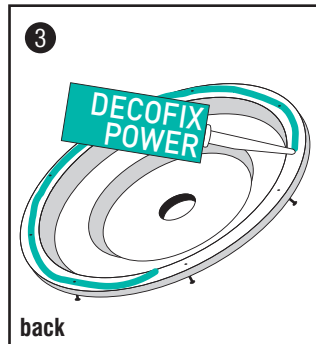
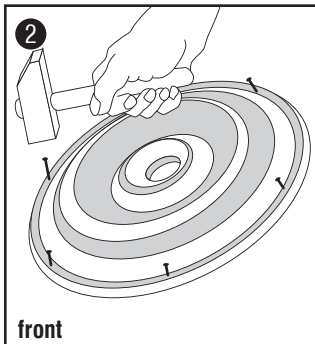

Use DecoFix Power plus nails (if possible) | Gebruik DecoFix Power en (indien mogelijk) spijkers bijkomend bij de lijm | Utilisez DecoFix Power et (si possible) aussi des clous en plus de la colle | Verwenden Sie DecoFix Power und (wenn möglich) zusätzliche Nägel | Use DecoFix Power y si es posible también clavos | Используйте клей DecoFix Power и (если возможно) гвоздики для дополнительной фиксации молдингов

FINISH
AFWERKING
FINITION
AUSFÜHRUNG
ACABADO
ОТДЕЛКА

